

# Ventilator N29



# Ventilator N29

- ✓ Compact
- ✓ Gebruiksvriendelijk



Een centrifugaal ventilator bedoeld voor gebruik met Nederman afzuigapparatuur.

Noot! De ventilator niet gebruiken in explosiegevaarlijke omgeving of voor transport van ontvlambare of explosieve gassen.

# Ventilator N29





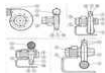
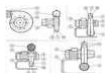







Certificeringen	CE
Installatie	Binnen, Buiten
Materiaal	Ventilatorbehuizing: plaatstaal / Waaier: plaatstaal
Geschikt voor explosief stof	False
Omgevingstemperatuur	-20 to +40 C (-4 F to 104 F)
Frequentie (Hz)	50
Aantal fase	3

## Modellen

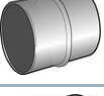





	Artikelnummer	Voltage (V)	Amperage (A)	Gewicht (kg)	Vermogen (kW)
	14510129 <sup>[1]</sup>	230/400	7,9/4,6	32	2,2
	14510829	230/400	7,9/4,6	27,5	2,2
	14522529 <sup>[1]</sup>	230/400	5,5/3,2	35	1,5
	14522629	220-240/380-420	5,5/3,2	21	1,5

<sup>[1]</sup> With fan bracket

## Accessoires

	Accessoires	Artikelnummer
	Koppelbus Ø75 mm	14503626
	FMS 2,5-4, ventilatorstarter inclusief thermische motorbeveiliging 2,5 - 4A	14502337
	FMS 4-6,3, ventilatorstarter inclusief thermische motorbeveiliging 4 - 6,3A	14502437
	Verloopadapter Ø125 mm / Ø100 mm	14341077
	Verloop Ø125 mm / Ø75 mm (zwart)	14341080
	Koppelbus Ø100 mm	14504626
	Koppelbus Ø125 mm	14505626
	Koppelbus Ø150 mm	14506626
	Inlaatadapter voor slang Ø160 mm	14510326
	Verloopadapter Ø160 mm / Ø75 mm	14510426
	Verloopadapter Ø160 mm / Ø100 mm	14510526
	Verloopadapter Ø160 mm / Ø125 mm	14510626
	T-stuk Ø160 mm inwendig / 2 x Ø100 mm uitwendig	14510726

## Accessoires

	Accessoires	Artikelnummer
	Verloopadapter Ø160 mm / Ø150 mm	14511226
	Koppelbus Ø160 mm	14511326
	Aluminium mondstuk met magneet	14500226
	Polycarbonaat mondstuk met magneet	14501226
	T-stuk Ø125 mm inwendig / 2 x Ø125 mm uitwendig	14500726
	T-stuk Ø125 mm inwendig / 2 x Ø75 mm uitwendig	14500826
	Foot stand for fan 529.	14321745

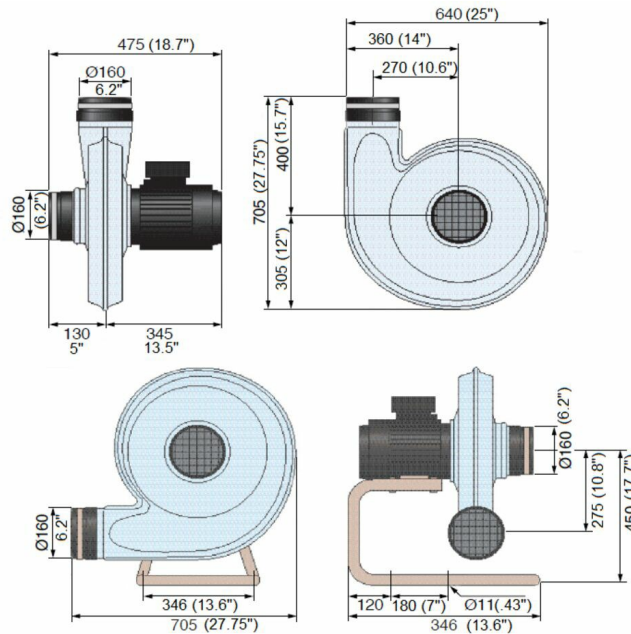

N29 fan, version with and without stand

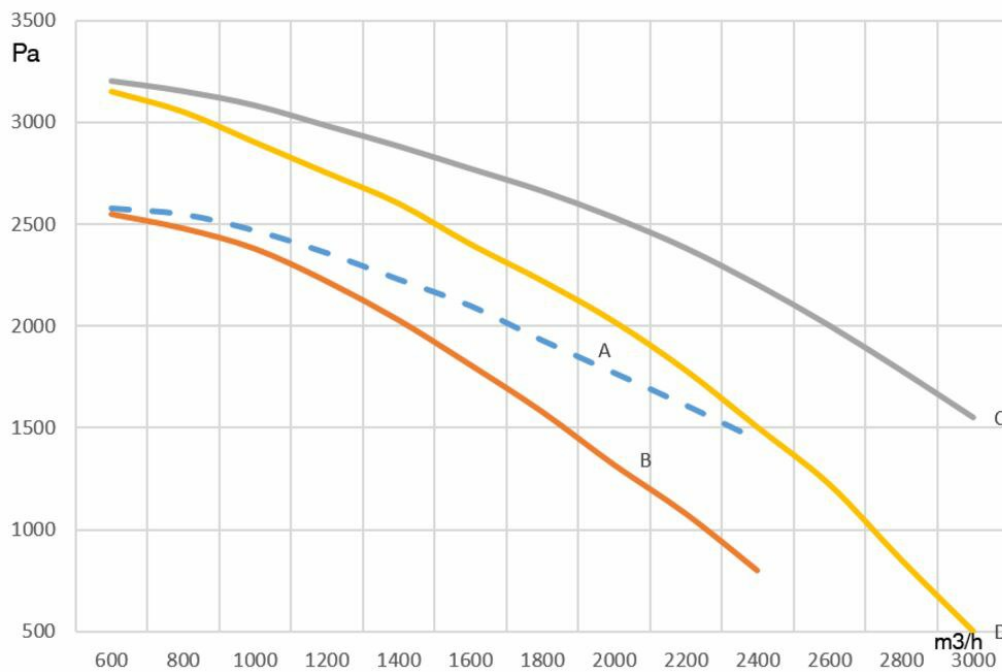

A = Fan total pressure (1,5 kW) B = Fan static pressure (1,5 kW) C = Fan total pressure (2,2 kW) D = Fan static pressure (2,2 kW)